



# Model C1 Dual-Mode Exhaust Bypass Valve Controller for Camaro, Corvette, Aston Martin and others.

Note: These instructions are available on our web site

[www.forzacomponenti.com/documents.html](http://www.forzacomponenti.com/documents.html)



## 1. The Exhaust Bypass Valve Controller

The Exhaust Bypass Valve Controller allows the driver to remotely control the exhaust bypass valves by intercepting the signal to the vacuum solenoids. Using the Forza 3-Way Controller, you have two modes of operation:

1. **Normal Mode** ... In this mode, the controller allows the vehicle's ECU to control the exhaust bypass valves. This is the default mode.
2. **Always Open Mode** ... The controller will intercept the ECU signal and keep the exhaust bypass valves always open.

You can use either the included remote control transmitter or a manual on/off switch that you can install inside the passenger compartment. Using either method, you can select either of the two modes of operation.

Installation does not require any wiring modifications or splicing into the car's electrical system. The unit is installed using the plug and play principal. If you are comfortable performing simple maintenance tasks on your car, you should not have any problems installing the kit yourself. If you are not comfortable performing maintenance tasks on your car, you should consult with your technician who performs the service on your vehicle.

## 2. Warranty

Forza Componenti warrants the Exhaust Bypass Valve Controller for 12 months after receipt of the unit. Any warranty claims must be made by contacting the company. During the warranty period, the company will repair or replace the unit. User is responsible for return shipping costs. Within the first 15 days after receipt of the unit, if the buyer wishes to return the unit, Forza Componenti will provide a full refund of the purchase price. Upon receipt of the unused, un-installed unit, a refund will be given. User is responsible for return shipping costs.

## 3. Disclaimers

Every effort has been made to assure that the Exhaust Bypass Valve Controller will be compatible with the vehicle that the unit is to be installed. The user is responsible for assuring that installation and use of the Exhaust Bypass Valve Controller is compatible with the vehicle exhaust and engine management system. Forza Componenti shall not be responsible for any damages to the host vehicle arising out of the use of, or otherwise related to, the Exhaust Bypass Valve Controller.

Users are responsible for ensuring their own compliance with legal requirements concerning noise abatement in their area. Forza Componenti assumes no responsibility should your vehicle become out of compliance with any relevant laws and regulatory requirements due to installation of the Exhaust Bypass Valve Controller.



## 4. Exhaust Bypass Valve Controller Kit Contents

### 4.1 Included in the kit

- Remote Controller Unit
- Two fuse taps
- One 5 amp and one 10 amp fuse
- Wiring to connect the controller to the fuse taps
- One Remote control transmitter (extra transmitters available)
- 3M Dual Lock Mounting Tape
- Nylon cable ties (not shown)

### 4.2 Not included in the kit

A manual switch if you plan to use it instead of the remote control transmitter

### 4.3 Installation Steps

Follow these steps in the order presented.

1. Check the Forza web site for additional information and details ...  
<http://www.forzacomponenti.com/vehicles.html>
2. Check the vehicle's exhaust bypass valves function
3. Configure the Bypass Controller Module
4. Determine mounting position for the Control Module
5. Install the fuse taps and electrical control wires and connect to the Control Module
6. Verify electrical continuity
7. Install manual control switches if you choose to use this option
8. Verify operation of Controller



## 5. Check the Vehicle's Current Exhaust Bypass Valve Functionality

- Ensure that the exhaust bypass valve(s) are functioning.
- Find the exhaust bypass valve(s) on your vehicle.
- With the engine off and no vacuum available to the exhaust valves, observe the default position – they should be Open. Depending on the vehicle, the valves may remain open or they may close. In either case, though, as your engine RPM increases, for example normal driving, the valves should close. Then, at some point in the engine RPM range, the valves should open when you reach a predetermined threshold level.
- If the valve(s) do not perform as designed, you will have to determine the cause. It may be a faulty vacuum line, a faulty valve or vacuum solenoid or an electrical connection to the vacuum solenoid that may be at fault. Correct the situation before proceeding.

## 6. Configure for Remote Transmitter or Manual Switch Operation

The controller can be used with either the included remote transmitter or with a manual switch that you would provide.

The remote control transmitter option is easier to install as no additional wire to route to a switch but you have risk of potential loss of remote transmitter and you will have replace the battery occasionally. The manual On/Off switch requires that your route a control wire to a switch that you intend to use, but you likely have longer term reliability, no worries of misplacing the transmitter and no batteries to replace.



The controller is shipped with the remote transmitter option enabled. If you wish to use a manual On/Off Switch, you will need to provide the switch and change the controller configurations as follows, otherwise, skip to the next step.

- Remove the lid from the controller
- Locate the small slide switch labeled "Rem – Man".
- Place the switch in the Man (manual) position. Note: once you position the switch in the Man position, your remote transmitter will no longer function as a control device.
- Reinstall the lid

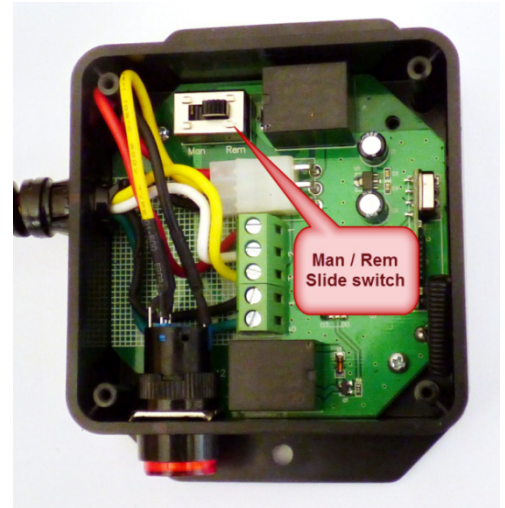

## 7. Install the Controller Module

Before proceeding with installation, refer to the Vehicle *Specific* Information on page 5 for information that may be unique to your vehicle.

### 7.1 Locate the Vehicle Fuse Block

Locate the vehicle fuse block (refer to *Appendix*) and remove the fuse cover if it is present.

### 7.2 Temporarily Position the Control Module

Locate the controller module in a location of your choice. Typically, this will be near the fuse block. Refer to the *Appendix* for Vehicle Specific Information

### 7.3 Install the Fuse Taps

Note: When installing the fuse taps, it is important to orient the tap into the fuse block position with correct polarity. Each fuse location has a "hot" side and "cold" side. Specifically, one side of the fuse will measure +12V when checking to vehicle ground and the other will measure 0V.

In the photo on the right, +12V will be always be on the left side of the fuse tap and 0V will always be on the right.

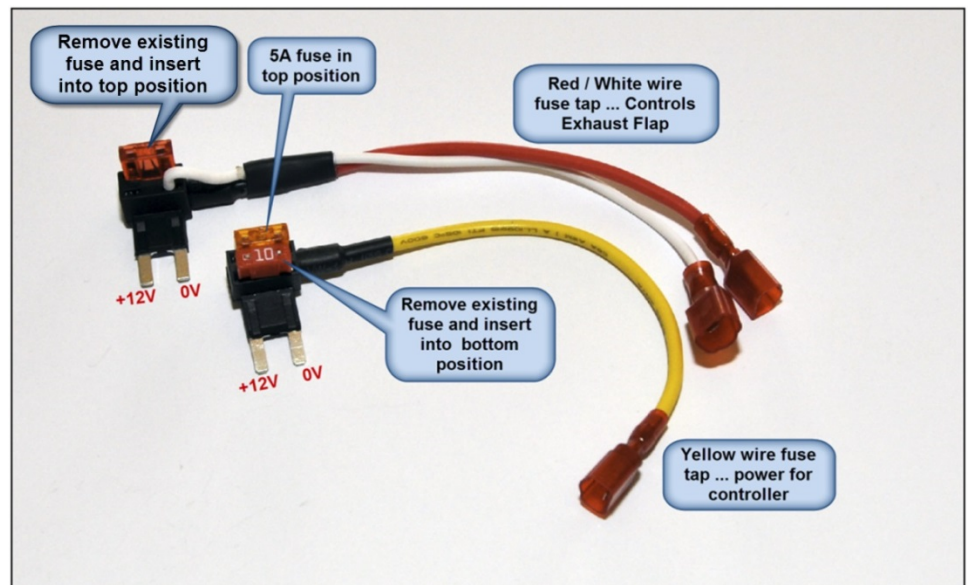

If after inserting the yellow wire fuse tap, you discover no power to the controller unit, you may have reversed the polarity. In which case, remove the fuse tap and reverse position. Orient the red wire fuse tap the same.

**Caution:** Fuse locations in the fuse block may be continuously supplied with 12 volts. Care must be taken to avoid shorting any connections.

#### 7.3.1 Install the Red and White Wire Fuse Tap

- Remove the cover to the factory fuse block if there is one.
- Locate and remove the fuse that is the control fuse for the Exhaust Bypass Valve. Refer to *Vehicle Specific Information* on page 5.
- Using the red & white wire fuse tap, install the fuse just removed and insert into the top position on the fuse tap.
- Install this fuse tap in the position on the fuse block where you removed the fuse.
- The red/white fuse tap orientation is not important. You can install it any way that it fits.



### 7.3.2 Install the Yellow Wire Fuse Tap

The yellow wire fuse tap is used to provide power to the controller module. Select an existing fuse in the same fuse block. This fuse should be far enough away from the red wire fuse tap to allow room to install both of the fuse taps. Refer to *Vehicle Specific Information* on page 5 for suggestions for fuse locations to use for specific vehicles.

- Remove fuse you have selected and insert this fuse in the **bottom** position on the yellow wire fuse tap.
- Insert the 5A or 10A fuse (included with controller kit) in the **top** position of the fuse tap.

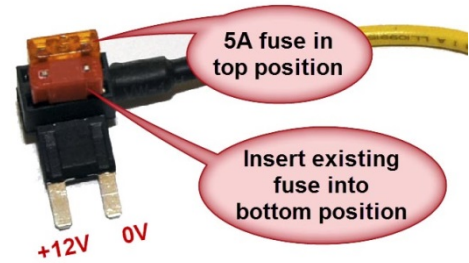

- Install the yellow wire fuse tap in the position on the fuse block where you removed the fuse. The orientation of the yellow fuse tap is important to assure that the controller is fuse protected. NOTE: Refer to *Vehicle Specific Information* on page 5 for correct orientation of the fuse tap in the fuse block.

Note: You may have to use a fuse location that is continuously “hot”, i.e., not switched with the ignition ... for example, Camaro Gen5. If this is the case, a small current drain (approx. 50mA) will be drawn by the controller module at all times. This is only a concern if you do not start your car for a long duration (e.g., > 4 weeks) or you do not use a battery tender. If this is the case, you should turn off the control module using the push-button switch on the side of the module enclosure. This will prevent any current drain on the battery. Of course, you will need to turn it back on again when you want to use the controller.

### 7.4 Connect the Control Wires and the Ground Wire

The wires are color coded. Connect the red, yellow and white control wires to the corresponding connectors on the controller and fuse taps. Coil any excess wire and secure with a cable tie. Connect the ground wire (green wire with ring terminal) to a suitable ground location. Make sure you have a good ground. Many metal screws on a car may not actually provide a good ground.

### 7.5 Check Electrical Continuity

Turn on the ignition. Using the master On/Off switch on the controller module, turn on the controller. The LED indicator light on the switch should illuminate. If it does not, check the connections – ensure you have a good ground connection and that the polarity of the yellow fuse tap is correct.

### 7.6 Connect the Manual Switch Control Wires if Applicable, otherwise skip to next step.

- If you intend to use the Manual Switch option, you must provide your own manual On/Off switch.
- Splice into the black wire on the control module. Connect the wire to one of the switch contacts and the ground the other switch contact.
- Ensure that you have configured the control module for manual switch option. Refer to *Configure for Remote Transmitter or Manual Switch Operation* on page 2.

### 7.7 Verify Operation of the Controller

With the ignition turned on, use the remote control transmitter or the manual On/Off switch; verify operation by pressing the buttons on the transmitter or the switch. You should hear a faint clicking sound of the relays opening and closing inside the control unit module.

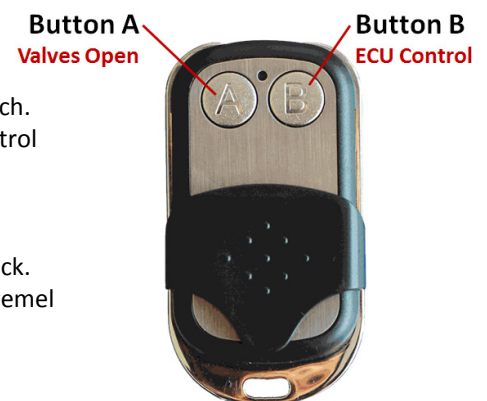

### 7.8 Reinstall the Fuse Block Cover

Replace the fuse block cover with the three wires accessible from outside the fuse block. You may have to trim some material from the fuse block or the fuse block cover. A Dremel or small utility knife will generally be the only tool you will need for this. Refer to *Vehicle Specific Information* on page 5 for any additional information.



### 8. Vehicle Specific Information

Always check our web site for current vehicle information.

<http://www.forzacomponenti.com/vehicles.html>

#### 8.1 Corvette C6

- Fuse Block is located under on passenger side of vehicle under instrument panel
- Install Red/White Wire Fuse tap in fuse position labeled "EXH MDL"
- Recommend install Yellow Wire Fuse in fuse position labeled "HTD SEAT/WPR RLY" which is a switched fuse with the ignition.
- Orient the yellow fuse tap with wire facing left with fuses on taps facing up. The red/white fuse tap orientation is not important.

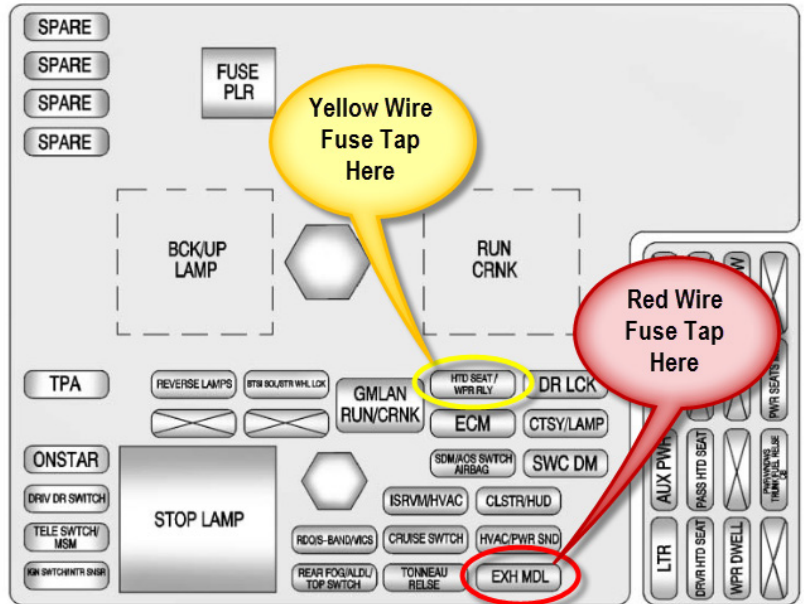

#### 8.2 Corvette C7

Use the illustration here as a reference for locating the fuses and aligning the fuse taps. It is best to locate the yellow fuse tap using a location that is switched to the ignition ... refer to *Install the Yellow Wire Fuse Tap* on page 4. The two locations suggested below should be verified to use the one that provides the switched connection.

- The fuse block is located in the engine bay. The lid of the fuse box has been used as the installation point for the controller module, but this has proven to be inappropriate (see below).
- Install the Red/White fuse tap in position #41 (2014 Corvette) or position #42 (2015+ Corvette) which is labeled, "Exhaust Valve". The orientation of the red/white fuse tap is not important.
- It is important that the yellow fuse tap is oriented correctly to assure that the controller is fuse-protected. To determine the correct orientation of the yellow fuse tap, choose a suitable location to install the yellow fuse tap. We recommend trying fuse location F17 or F30. Remove the existing fuse and insert it into the lower position on the yellow fuse tap. Keep the 5A fuse that came with the yellow fuse tap inserted in the top position. Insert the yellow fuse tap where you removed the fuse.

- 15A Fuse for Heater, Ventilation, & A/C Controls
  - Fuse # 17
  - Yellow fuse tap here
- Or -
- 15A Fuse for Seat Fan
  - Fuse # 30
  - Yellow fuse tap here

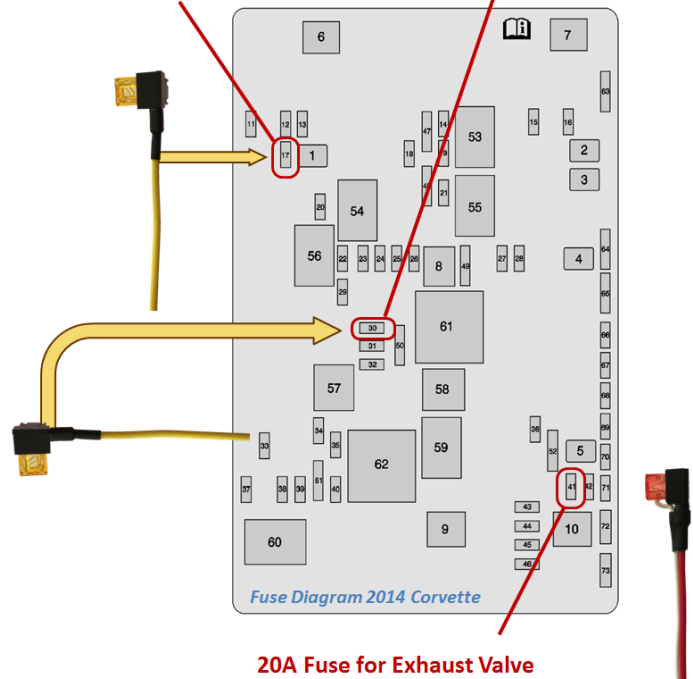

- 20A Fuse for Exhaust Valve
  - Fuse # 41 – 2014 Corvette
  - Fuse # 42 – 2015 & 2016 Corvette
  - Red/White fuse tap here



- To determine if the fuse location is switched to the ignition – start with the ignition turned off. Plug the yellow fuse tap quick connector into the controller module. Attach the ground wire of the controller module to a suitable ground on the car. With the yellow fuse tap inserted into the fuse slot, press the master push-button switch on the controller to the ON position. If the switch illuminates, then the fuse location is NOT switched to the ignition. Try another fuse location. If the push-button does not illuminate, proceed with the next step.
- Remove the top fuse from the yellow fuse tap (this is the 5A amp fuse that the fuse tap came with). Insert the fuse tap in the fuse location you have chosen. Turn on the ignition and press the master power switch on the controller module. If the switch illuminates with the 5A fuse removed, the orientation of the fuse tap is incorrect. Reverse the orientation of the fuse tap and try again. If the orientation is correct, re-insert the 5A fuse in the top position of the yellow fuse tap and install the tap in the fuse location you have chosen.

The orientation of the yellow fuse taps shown in illustration here should be the correct orientation. But follow the procedure above to be sure. If the orientation of the yellow fuse tap is reversed, the controller will still function, but it will not be fuse protected.

### 8.2.1 Locating the Controller Module in the C7

There is limited space in the engine bay of the C7 Corvette. It is very important to avoid direct radiation to any exhaust components or other sources of high heat as this may damage the controller module enclosure. You should avoid the right side of the engine bay, including the top of the fuse box, although that may appear to be good location for the module. The left side of the engine bay provides greater air circulation, however even this side can get very hot, especially if you have the supercharged version or if you are running the car at very high RPM for extended times. See photos on the right.

If you install the controller in the engine bay, we suggest the left side in a location that provides air circulation and not exposed to direct heat radiation from exhaust system components. We also strongly recommend that a heat shield be placed around the controller module such as aluminized fiber glass.

The best location for your exhaust controller is inside the passenger compartment. This will require routing the three wires through the firewall to the inside of the car. Look for a grommet in the firewall for existing cables and wires and route the three wires through, then find a suitable location under the instrument panel for mounting the controller. This will best protect the controller from any heat source.





### 8.3 Camaro Generation 5 (2010 to 2015)

Note: On the Gen5 Camaro, the exhaust bypass valves are open when you first start the car ... and they remain open when the engine is idling and at low RPM. As you start to increase engine RPM, the valves will close. They will then remain closed until 3000 RPM or so. When you install the Forza Controller, you will not notice any difference in exhaust tone at low RPM. But, as you increase RPM, the exhaust bypass valves will remain open. It is at this mid-range engine RPM that the difference will be noticed.

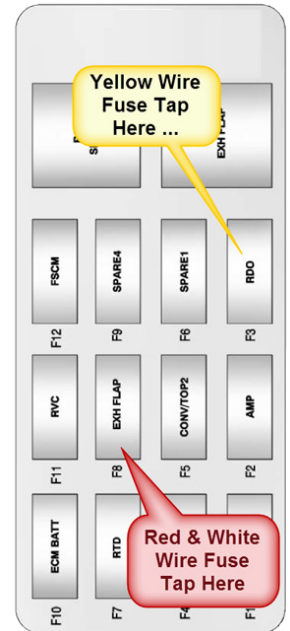
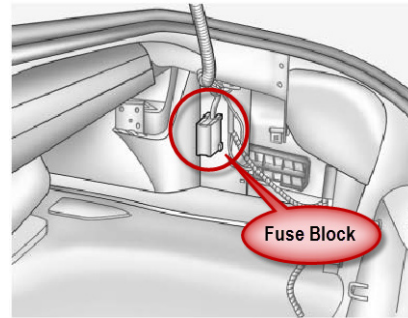

- A good location to install the control module is in the battery / spare tire well under the floor panel. This will give good access to the controller module so you can access the push-button On/Off switch without having to remove the side panel.
- The fuse block on the Camaro is located in the right side of the trunk behind a panel.
- Access fuse block by removing carpet panel in trunk and then removing rear sill plate and passenger side trim retainers
  - Remove convenience net retainers, the rear sill plate and passenger side trim retainers:
  - Remove black plastic threaded fastener at bottom of panel
  - Remove or unfasten the carpet trim from upper right black plastic button type rivet
  - Pull back carpeted panel on right to gain access to the fuse block
- Install Red and White Wire Fuse tap in fuse position labeled “EXH FLAP”. The red/white fuse tap can be oriented any way that it fits.
- You can use any fuse position for the yellow wire fuse tape. We recommend position F3 (RDO).
- Orient the yellow fuse tap with wire facing down and the fuses facing left. If you orient it in opposite direction, the controller will still function, but it will not be fuse protected.
- You will have to trim some plastic material away from the slots in the fuse block cover to route the three wires. The plastic can be trimmed easily with a sharp utility knife. And, you may find that the cover will not fully seat in place with the fuse taps in place. An easy and safe solution is to use a cable tie to secure the fuse cover in place. Route the cable tie behind the fuse block and thread the ends through cover clips to secure in place.

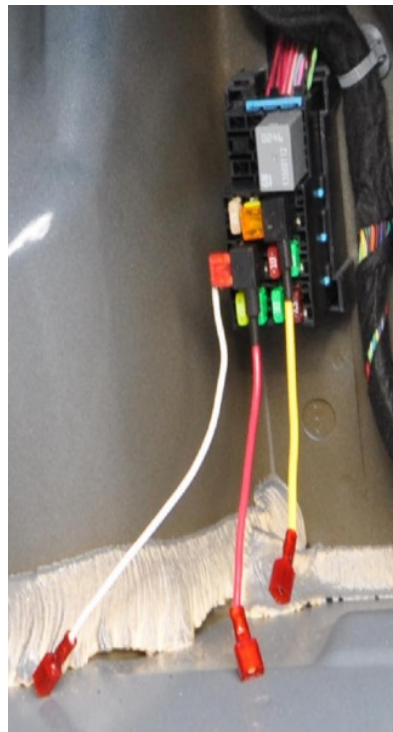

If there is interference when you attempt to re-install the fuse block cover, use cable ties to secure the fuse block cover in place over the fuses. Merely thread a cable tie to keep the cover to keep it in place. As the fuse block is hidden away, there is no danger of compromising the fuses or the electrical connectors, but it is good idea to secure the fuse block cover in place.



### 8.3.1 Zero Current Drain Installation – Camaro Generation 5 Only

The fuse block in the rear of the Camaro does not have any fuse locations that are switched with the ignition. When the yellow wire fuse tap is inserted, there will be a continuous current drain as long as the controller master power switch is on. The amount of current drain is small, but leaving the car unattended for an extended period of time could result in a drain that could deplete the battery more rapidly than otherwise. How much and how soon and is difficult to predict. The Forza controller’s current draw will add to the existing current draw that your vehicle is pulling when the ignition is off. In practical terms, this will hasten the discharge rate of the car’s battery when the vehicle is unattended. A typical battery will discharge to the point of not starting the car is about 80 to 100 days. With the additional current draw of the Forza controller, the battery could discharge to the point of not starting the car in 30 to 50 days.

*If you start your car frequently, e.g., a daily driver, there should not be any problem with this current drain. However, if you leave your vehicle unattended for any extended period, we recommend that you either turn off the controller using the master On/Off switch or place your vehicle on a battery tender.*

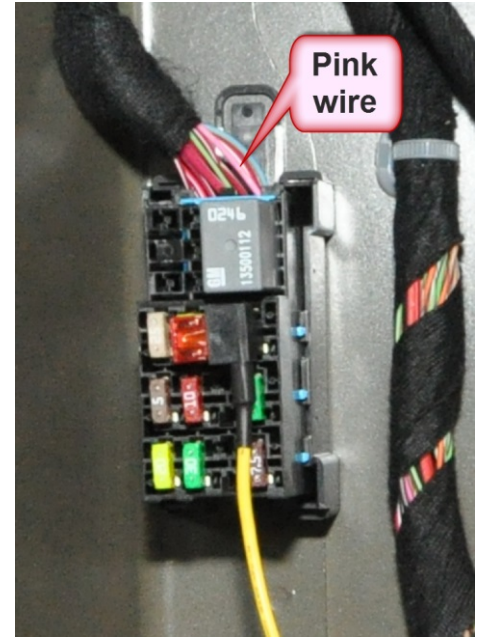

If you wish to have a zero current drain installation that is switched to the ignition, you will have to obtain the power for the controller (yellow fuse tap) from a power source that will provide this switching function. There is pink wire located at the rear fuse block that could be used for this purpose. If you are confident in your ability to tap into this wire, this wire can be used as a switched power source. We do not recommend this action, however, if you wish to use this wire for the +12V power source, exercise caution and use high quality electrical components designed for automotive use. Using an insulation displacement electrical tap connector, you can splice the yellow power wire into the pink wire as shown in the illustration. Use an inline fuse if you take this approach.



Insulation Displacement Electrical Tap Connector

A better approach, and our recommendation, is to use a switched fuse location in the instrument panel fuse block. Install the yellow fuse tap in the same manner described in this document and route a wire back to the controller module to provide power. For example, the instrument panel fuse location F17 is a switched fuse for one of the power ports in your car. You can install the yellow fuse tap in this location and when you switch off the ignition, power will be interrupted to the controller module avoiding any additional current drain from the controller module.

## 8.4 Camaro Generation 6 (Model Year 2016 +)

Locate the controller module in a location of your choice. Typically, this will be near the fuse block but avoid using the engine side of the fuse block. See *Important Note for Generation 6 Camaro* on page 10. Using the included 3M Dual Lock adhesive strip, you can install the controller module in any convenient location. The photos in this section show it being installed on the engine side of the of the fuse block. But, anywhere in the engine bay is OK. You should avoid obvious sources of direct heat.

### 8.4.1 Install the Red and White Wire Fuse Tap





- Refer to your owners' manual and locate and remove the fuse that is the control fuse for the Exhaust Bypass Valve. This should be Fuse F51. This location could vary depending on model year. Check your owner's manual.
- Remove the fuse in F51 and insert it in the **upper** portion of the **red/white** fuse tap. Insert the red and white fuse tap in the fuse F51 location. The orientation of the red/white fuse tap is not important. Orient any way that fits. See illustration below.



#### 8.4.2 Install the Yellow Wire Fuse Tap (see illustration below)

- The yellow fuse tap with the 5A fuse tap in the top position can be located in any location that allows it to fit easily. We recommend using fuse location that is switched to the ignition. It has been found that fuse locations that are switched to the ignition can vary.

**Note:** If you discover that you have to use a fuse location that is continuously “hot”, i.e., not switched with the ignition, this will result in a small current drain (approx. 50mA) will be drawn by the controller module at all times. This is only a concern if you do not start your car for a long duration (e.g., > 4 weeks) and you do not use a battery tender. If this is the case, you should turn off the control module using the push-button switch on the side of the module enclosure. This will prevent any current drain on the battery. Of course, you will need to turn it back on again when you want to use the controller.

- Choose a suitable location to install the fuse tap. We recommend trying fuse location F63 – O2 sensor. Remove the existing fuse at F63 and insert it into the **lower** position on the yellow fuse tap. Insert the yellow fuse tap where you removed the fuse. Note: the orientation of the yellow fuse tap could vary depending on the fuse location you choose to use.
- To determine if the fuse location is switched to the ignition – start with the ignition turned **off**. Plug the yellow fuse tap quick connector into the controller module. Attach the ground wire of the controller module to a suitable ground on the car. Insert the yellow fuse tap into a fuse location that you wish to test. Press the master push-button switch on the controller to the ON position. If the switch illuminates, then the fuse location is NOT switched to the ignition. Try another fuse location. Proceed to the next step once you have determined the location is switched to the ignition.
- **It is important that the yellow fuse tap is oriented correctly** to assure that the controller is fuse-protected. To determine the correct orientation of the yellow fuse tap – remove the top fuse from the yellow fuse tap (this is the 5A amp fuse that the fuse tap came with). Insert the fuse tap in the fuse location you have chosen. Turn on the ignition and press the master power switch on the controller module. If the switch illuminates with the 5A fuse removed, the orientation of the fuse tap is incorrect. Reverse the orientation of the fuse tap and try again. If the orientation is correct, re-insert the 5A fuse in the top position of the yellow fuse tap and install the tap in the fuse location you have chosen.

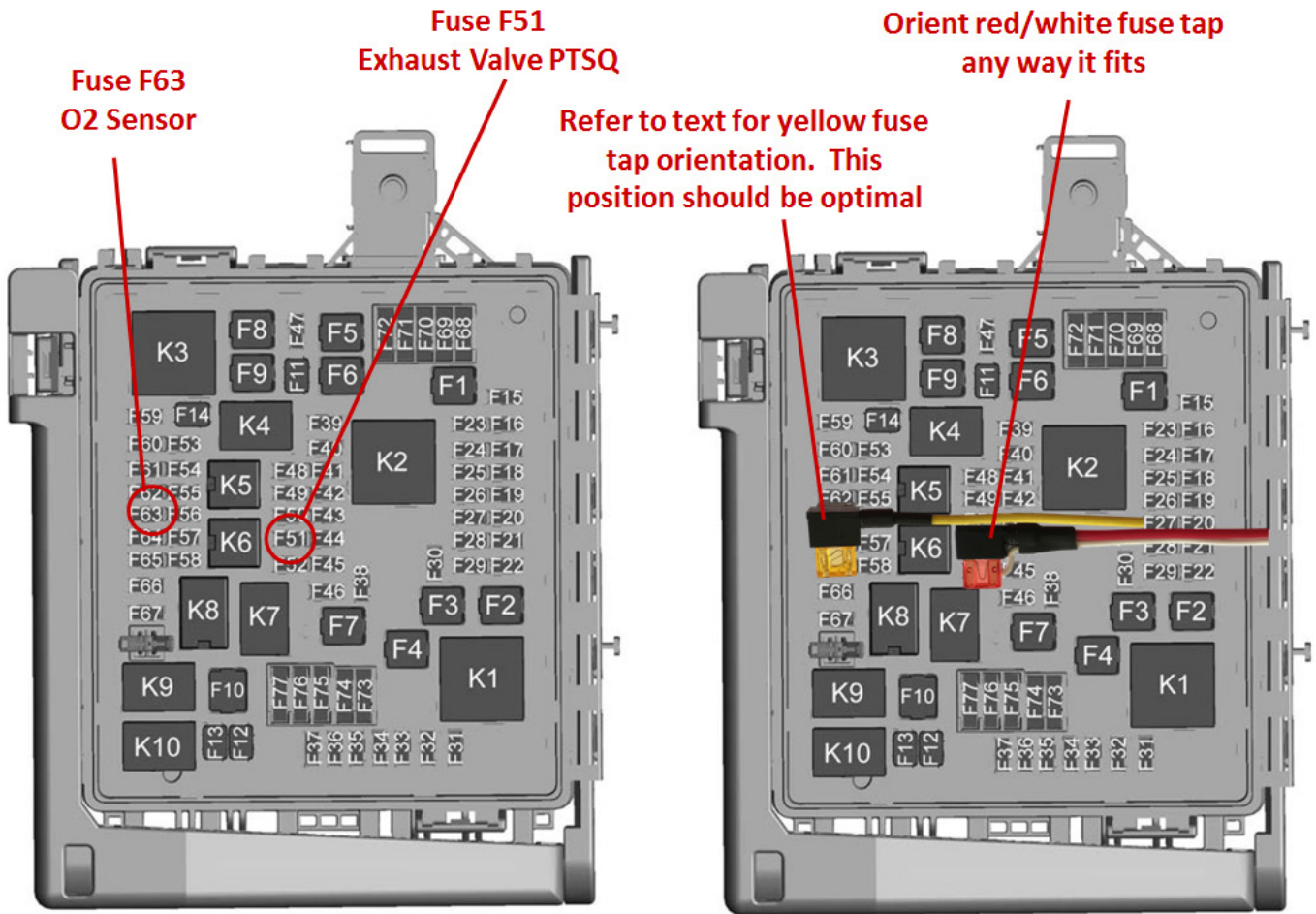

### 8.4.3 Complete the Installation

- Secure controller module (we recommend using the 3M Dual Lock adhesive mounts, but you can also secure the controller with screws or a cable tie)
- File or cut a notch in the corner of the fuse block to route the wires
- Connect the fuse taps to the controller module
- Replace the fuse block cover and secure all wires with cable ties or similar

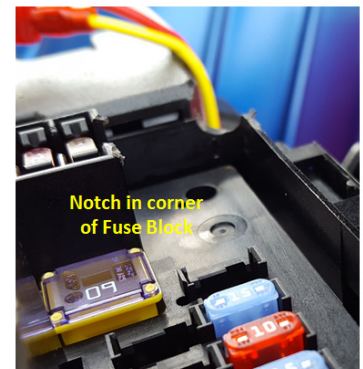

### 8.4.4 Important Note for Generation 6 Camaro

Avoid locating the controller near sources of high heat such as direct radiation of heat from the exhaust manifold. An attractive location for the controller module is on the engine side of fuse block. This location is not recommended as any object located here will be subject to direct radiation of heat from the exhaust manifold.

Use a different location or provide shielding to minimize heat radiation.

The best location for your exhaust controller is inside the passenger compartment. This will require routing the three wires through the firewall to the inside of the car. Look for a grommet in the firewall for existing cables and wires and route the three wires through, then find a suitable location under the instrument panel for mounting the controller. This will best protect the controller from any heat source.



Do not install controller on engine side of fuse block



If installed here, high heat from exhaust manifold may compromise the exterior push button switch

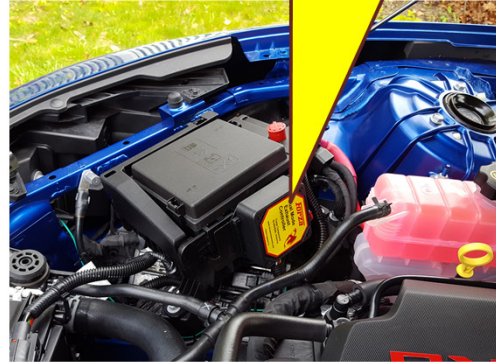

A better location away from exhaust manifold heat.



### 8.5 Aston Martin Vantage V8, DBS, DB9, others

Note: On some Aston Martins, the exhaust bypass valves are open after you start the car and they remain open when the engine is idling. As you start to increase the engine RPM, the valves will close. They remain closed until you reach a predetermined threshold which may be about 4000 RPM or so. With the controller, you will force the valves open at all times so you would notice the difference only in the mid-range of engine RPM

- The fuse block is located in the trunk (boot) or possibly under one of the car seats.
- Install Red and White Wire Fuse tap in fuse position "Fuse 22". The actual fuse number may be different depending on which model Aston Martin you have. *Check the fuse diagram to verify it is the fuse that controls the exhaust flaps or exhaust bypass valves.* Remove the existing fuse from this position and install the fuse in the top position on the fuse tap. *Two sets of fuse taps are included. One set for Standard ATO fuses and one set for Mini-ATO fuses. Use the set that is correct for your vehicle.* The red/white fuse tap orientation is not important and can be oriented any way that it fits.
- Use a nearby fuse on same side of fuse block for Yellow Wire Fuse tap. Select a fuse that is switched with the ignition. Remove the existing fuse from the position that you select and place this fuse in the bottom position of the yellow wire fuse tap. The top position of the yellow wire fuse tap will contain the 5A fuse included with your kit. Verify that with the ignition OFF, that no power is delivered to the controller module (push-button switch on controller is depressed). If there is power with the ignition off, try selecting another fuse that is switched OFF with the ignition.
- The correct orientation of the yellow fuse tap is with wire facing the outside of the fuse block and fuses facing left. If you orient the yellow fuse tap in the opposite direction, the controller will still function, but it will not be fuse protected. Refer to instructions for Camaro Gen 6 for technique to determine correct orientation for the yellow fuse tap.
- Replace the fuse block cover. You may need to trim a slot in the fuse block or the fuse block cover to route the wires.

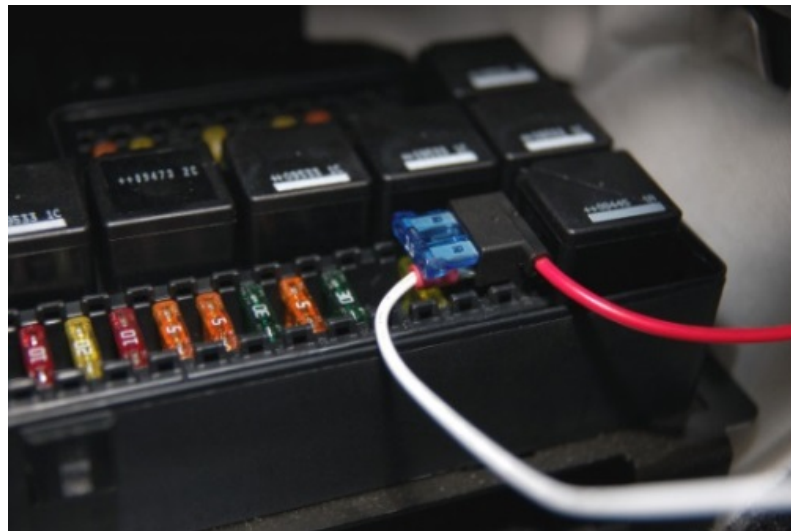



## 9. Troubleshooting

Indication	Possible Causes	Solution
<b>Pressing remote button has no effect. You cannot hear the relays opening or closing inside the controller module.</b>	<ul style="list-style-type: none"><li>• Master push-button switch is not depressed to the ON position.</li><li>• Ground wire not attached to good vehicle ground.</li><li>• Fuse taps inserted wrong way causing reverse polarity</li><li>• The controller module is configured to use the manual switch option.</li><li>• The remote transmitter is not programmed to the controller module.</li><li>• The remote transmitter has low battery</li><li>• The remote transmitter is not programmed to the control module</li></ul>	<ul style="list-style-type: none"><li>• Check that master switch is depressed to ON.</li><li>• Disconnect ground wire from current location and connect to a ground point that you are sure provides continuity.</li><li>• Check orientation of fuse tap. Reverse orientation and recheck to see if corrects problem.</li><li>• Check the operation switch. If necessary, change the configuration on the controller module to use Remote option.</li><li>• Perform the steps to program the transmitter to the controller module receiver.</li><li>• Replace battery in remote transmitter</li><li>• Program the remote transmitter to the control module</li></ul>
<b>The manual switch does not open the valves.</b>	<ul style="list-style-type: none"><li>• The controller module is configured to use the Remote option.</li><li>• The manual switch is not connected properly.</li><li>• Fuse taps inserted wrong way causing reverse polarity</li><li>• Master push-button switch is not depressed to the ON position.</li></ul>	<ul style="list-style-type: none"><li>• Change the configuration of the controller module to use Manual option.</li><li>• Check continuity of the wiring to the manual switch. Make sure the ground side of the switch is connected to a good ground point on the car.</li><li>• Check orientation of fuse tap. Reverse orientation and recheck to see if corrects problem.</li><li>• Check that master switch is depressed to ON.</li></ul>
<b>Pressing remote button operates relays, but no power is available on devices on the vehicle</b>	<ul style="list-style-type: none"><li>• More than likely you forgot to install the fuse you removed from the fuse block into the bottom position on the yellow wire fuse tap.</li></ul>	<ul style="list-style-type: none"><li>• Check that the yellow wire fuse tap has two fuses installed. The upper fuse is for power to the controller module and lower fuse is the fuse for the original circuit.</li><li>• Insert both fuses into the yellow wire fuse tap as shown in <i>Install the Yellow Wire Fuse Tap</i> on page 4</li></ul>



### 10. Dual Lock Fastening Tape by 3M

Included in your kit are two strips of 3M Dual Lock fastener material.

- 3M TB3560 Type 250 Dual Lock Re-closable Fastener
- Rated for use in severe environments
- Very good holding power and able to release and re-use
- Thoroughly clean both surfaces of dirt and oil using a solvent that does not leave residue such as isopropyl alcohol.
- Apply Dual Lock to both substrate surfaces.

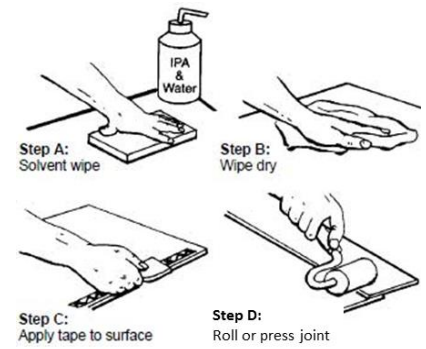

Mount a strip on the bottom surface of the controller module. Lightly press the other strip on this piece ... just enough to hold in place. Now position the controller in place. Gently apply pressure to stick the mating piece in place on the mounting surface. This will assure proper alignment of the two Dual Lock pieces. Once positioned, you can take the controller off and then press the piece on the mounting surface in place to assure a firm hold. Press each mounting piece on to the substrate. It will fully set in about an hour, but it should be fine to use immediately. Press the controller in place until you hear or feel a click.

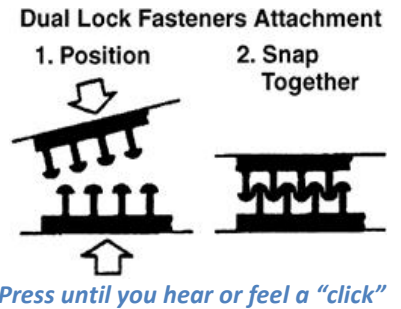

### 11. Adding or Replacing a Remote Transmitter

If you are adding or changing the key fob remote, you must program the control module receiver unit to recognize the new remote transmitter.

- Remove the lid from the control unit.
- Find the program button on the printed circuit board.
- Turn on the vehicle ignition to ensure power to the control unit and press the push button power switch to the 'On' position.
- Place the Man/Rem switch to the Rem position.
- While holding the key fob, momentarily press the "remote programming button" on the circuit board. The LED should flash.
- If you press and hold the programming button for a few seconds, you will erase all memory of any transmitters. If this occurs, then you must re-program all transmitters.

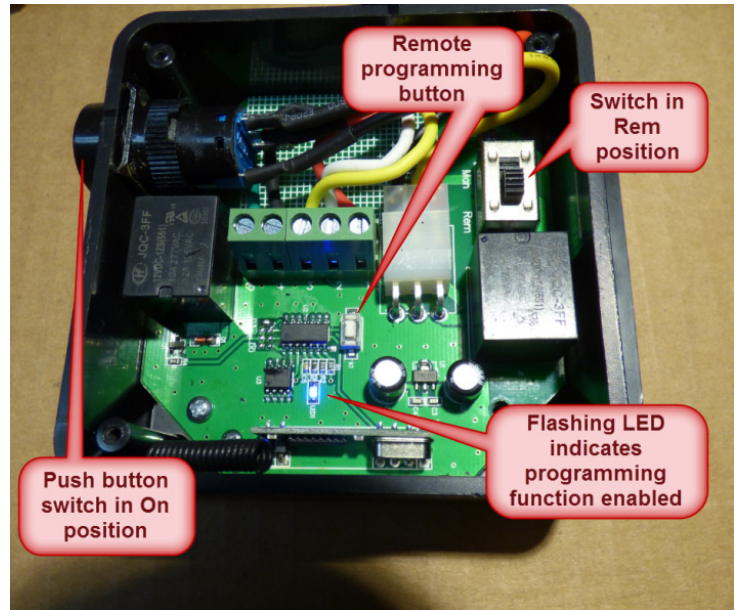

- Immediately after pressing the learn button, while the LED is flashing, press the left button on the remote transmitter. The LED on the control unit should go out.
- Your transmitter should now be programmed to the control module.
- Repeat for additional transmitters.
- Verify operation of all transmitters and replace the control unit lid.

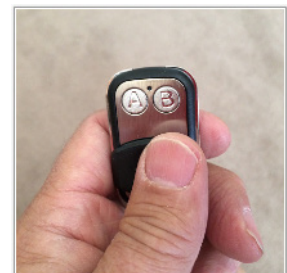



### 12. Using the Controller with Homelink Systems

The Homelink installed in the vehicle must support 433MHz. Some Homelink systems do not support this frequency (e.g., prior to 2014 in North America). The actual programming for the Homelink may vary by vehicle. Refer to your vehicle's owner manual for specific instructions on setting up the system.

In general, to program Homelink, press and hold the Homelink button you wish to program and hold until an indicator light slowly flashes. While the Homelink light is slowly flashing, hold the remote fob within a few inches of the Homelink. Press the transmit button on the fob for 3 to 5 seconds, then release and immediately press again. The sequence of pressing and releasing the fob button will prevent the fob transmitter from timing out before the Homelink can successfully clone the signal. Continue pressing and releasing the fob button until the Homelink indicator lamp goes solid or flashes rapidly. You will need to program one button on the Homelink for each function button on the transmitter fob.

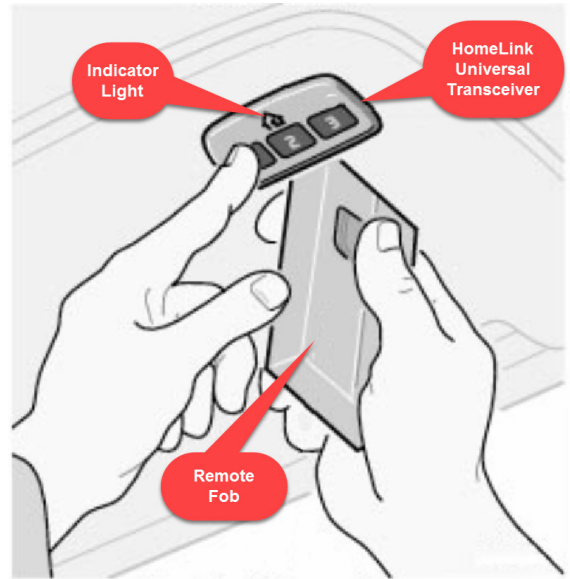

### 13. Manual Switch Options

Installation of a manual switch to control the exhaust bypass valves is an excellent alternative to using the remote control transmitter as it will provide higher reliability and durability and eliminate risk of losing the remote control transmitter. However, routing a wire to a switch in passenger compartment and installing a manual switch requires more effort than using the remote transmitter. On modern vehicles, finding a location may be difficult. If you have an unused location, you can install switch that matches the other switches on your car. Otherwise, you may wish to use a switch such a miniature toggle or rocker switch that you can install in an out-of-way location such as the center console or in ash tray.

Placement of a manual On/Off switch is only limited by your imagination. Some alternative positions include under the steering column or the driver seat.



Miniature Toggle Switch mounted in ash tray



Miniature SPST On-Off Toggle Switch



Round SPST On-Off Pushbutton Switch

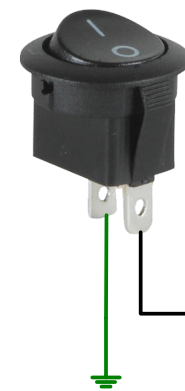

Round SPST On-Off Rocker Switch

Vehicle Ground

To Always Closed Wire on Control Module